

XM●-●06

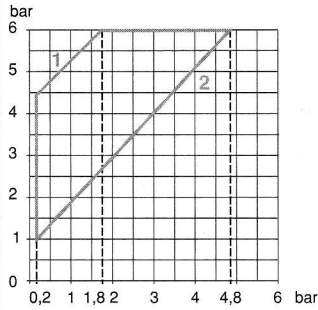

XM●-●12

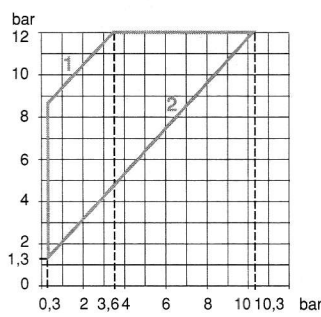

XM●-●25

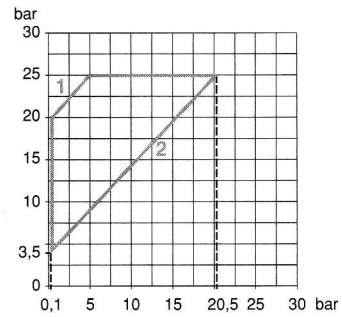

1 : Maximum differential - Ecart maximum - Maximale hysteresen - Intervalos máximos - Differenziali max - intervalos maximos
 2 : Minimum differential - Ecart minimum - Minimale hysteresen - Intervalos mínimos - Differenziali min - intervalos mínimos

MXM/XMA

XMP

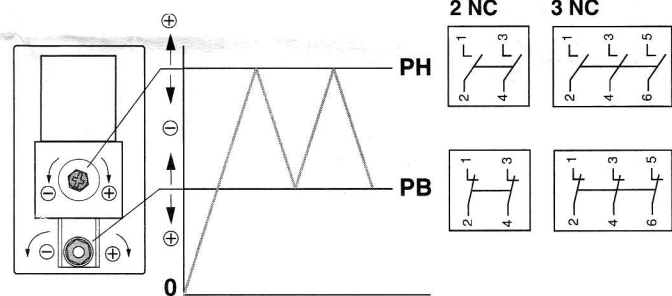
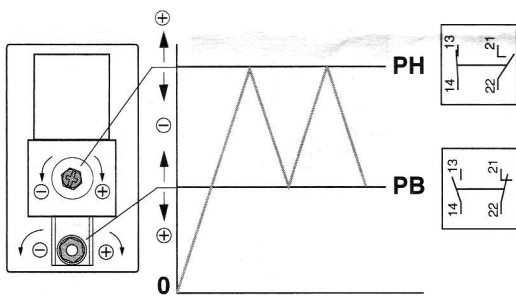

PH : High setting point - Point haut - Oberer Schaltungspunkt - Punto de disparo superior - Punto di scatto superiore - Ponto alto
 PB : Low setting point - Point bas - Unterer Schaltungspunkt - Punto de disparo inferior - Punto di scatto inferiore - Ponto baixo

Setting
 Réglage
 Einsellungen
 Adjustes
 Regolazioni
 Reglagem

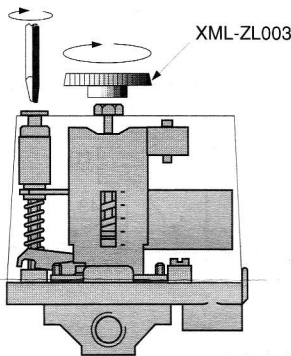

Fixing bracket
 Equerre de fixation
 Befestigungswinkel
 Escuadra de fijación
 Squadra de fissaggio
 Esquadro de fixaçao

XMA-ZL001

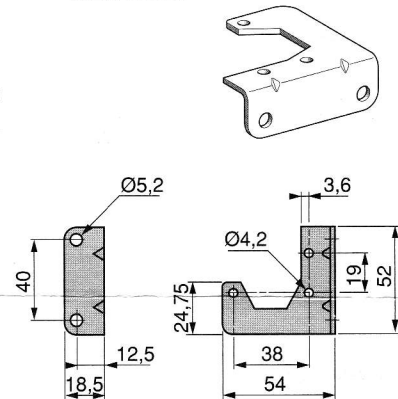

! DANGER / PELIGRO / DANGER		
<p>HAZARDOUS VOLTAGE</p> <p>Disconnect all power before servicing equipment.</p> <p>Electric shock will result in death or serious injury.</p>	<p>TENSION PELIGROSA</p> <p>Desenergice el equipo antes de realizarle servicio.</p> <p>Una descarga eléctrica podrá causar la muerte o lesiones serias.</p>	<p>TENSION DANGEREUSE</p> <p>Couper l'alimentation avant de travailler sur cet appareil.</p> <p>Une électrocution entrainera la mort ou des blessures graves.</p>

FOR XMA / XMX ONLY	<p>EXAMPLE EXEMPLE ESEMPIO</p>
SCALE MUST BE READ WHEN THE PRODUCT IS NOT TRIPPED	
SEULEMENT POUR XMA / XMX	
LECTURE DE L'ECHELLE A EFFETUER AVEC PRODUIT NON ENCLENCHE	<p>PRECISION: ±10% PRECISION: ±10% PRECISIONE: ±10%</p>
SOLO PER XMA / XMX	
LETTURA ETICHETTA DA EFFETUARE CON PRODOTTO A RIPOSO	